

Plummer Blocks,剖分式轴承座

Split Bearing Housings, Split Pillow Block Housings



SNG500 Series

For Self-Aligning Ball Bearings or Spherical Roller Bearings with Adapter Sleeves

Stehlagergehäuse · Paliers à semelle en 2 parties · Soportes de rodamientos · Soportes de Pie · Soportes Bipartidos · CHUMACERAS
CHUMACEIRAS · Корпуса подшипников · Стационарные подшипниковые узлы · Supporti ritri in due metà

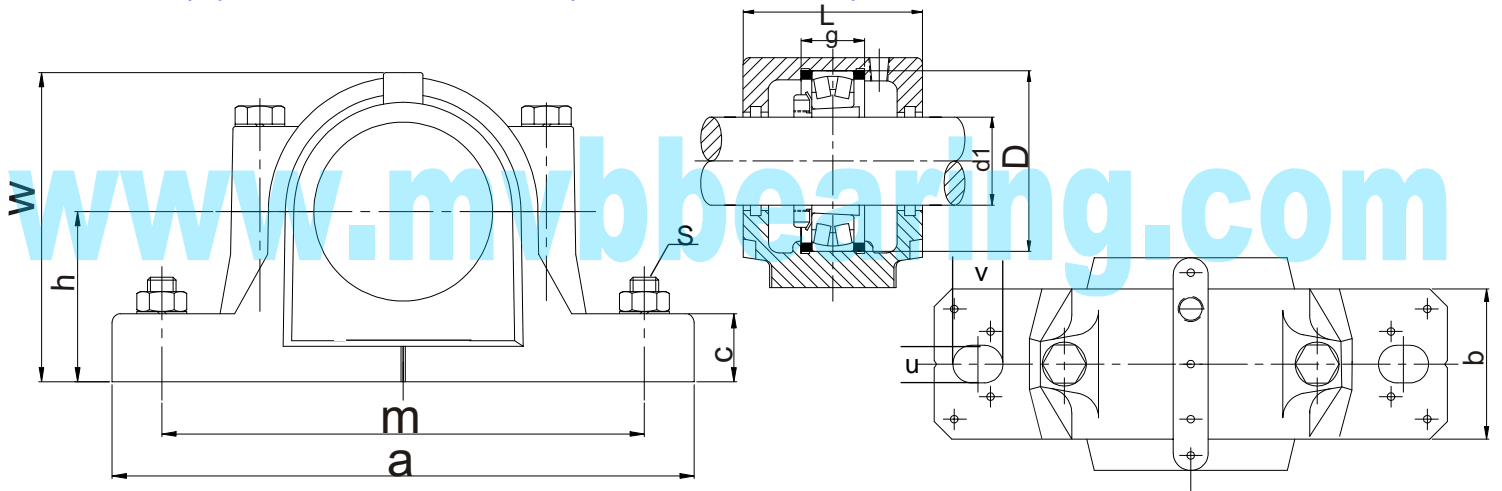

Tipo Type n.	Supporto Diam. albero Shaft DIA.			D H8	a	b	c	g H12	h jS11	L	w	m	S Bullone Bolt	U	V	d2 H12	d3 H12	f1
	mm metric	pollici / inches																
SNG507-606	30	1 ¹ / ₈	1 ³ / ₁₆	72	185	52	22	34	50	82	92	150	M12	15	20	46.5	54.5	5
SNG508-607	35	1 ⁵ / ₁₆	1 ³ / ₈	80	205	60	25	39	60	85	106	170	M12	15	20	51.5	59.5	5
SNG509	40	1 ¹ / ₂	1 ⁹ / ₁₆	85	205	60	25	30	60	85	109	170	M12	15	20	56.5	64.5	5
SNG510-608	45	1 ¹¹ / ₁₆	1 ³ / ₄	90	205	60	25	41	60	90	112	170	M12	15	20	62	70.5	5
SNG511-609	50	1 ¹⁵ / ₁₆	2	100	255	70	28	44	70	95	127	210	M16	18	23	67	75.5	5
SNG512-610	55	2 ¹ / ₈	2 ³ / ₁₆	110	255	70	30	48	70	105	133	210	M16	18	23	72	80.5	5
SNG513-611	60	2 ¹ / ₄	2 ⁵ / ₁₆	120	275	80	30	51	80	110	148	230	M16	18	24	77	85.5	5
SNG515-612	65	2 ⁷ / ₁₆	2 ¹ / ₂	130	280	80	30	56	80	115	154	230	M16	18	26	87	95.5	5
SNG516-613	70	2 ¹¹ / ₁₆	2 ³ / ₄	140	315	90	32	58	95	120	175	260	M20	22	29	92.5	101	5
SNG517	75	2 ¹⁵ / ₁₆	3	150	320	90	32	61	95	125	181	260	M20	22	30	97.5	106	5
SNG518-615	80	3 ³ / ₁₆	3 ¹ / ₄	160	345	100	35	65	100	140	192	290	M20	22	27	102.5	111	5
SNG519-616	85	3 ⁵ / ₁₆	3 ³ / ₈	170	345	100	35	68	112	145	209	290	M20	22	27	131	141	6
SNG520-617	90	3 ⁷ / ₁₆	3 ¹ / ₂	180	380	110	40	70	112	160	215	320	M24	26	32	137.5	147.5	6
SNG522-619	100	3 ¹⁵ / ₁₆	4	200	410	120	45	80	125	175	239	350	M24	26	32	147.5	157.5	6
SNG524-620	110	4 ³ / ₁₆	4 ¹ / ₄	215	410	120	45	86	140	185	271	350	M24	26	32	157.5	167.5	6
SNG526	115	4 ⁷ / ₁₆	4 ¹ / ₂	230	445	130	50	90	150	190	290	380	M24	28	35	167.5	177.5	6
SNG528	125	4 ¹⁵ / ₁₆	5	250	500	150	50	98	150	205	302	420	M30	35	42	177.5	187.5	6
SNG530	135	5 ³ / ₁₆	5 ¹ / ₄	270	530	160	60	106	160	220	323	450	M30	35	42	192.5	202.5	6
SNG532	140	5 ⁷ / ₁₆	5 ¹ / ₂	290	550	160	60	114	170	235	344	470	M30	35	42	202.5	212.5	6

Plummer Blocks,剖分式轴承座

Split Bearing Housings, Split Pillow Block Housings



SG500 Series

For Self-Aligning Ball Bearings or Spherical Roller Bearings with Adapter Sleeves

Stehlagergehäuse · Paliers à semelle en 2 parties · Soportes de rodamientos · Soportes de Pie · Soportes Bipartidos · CHUMACERAS
CHUMACEIRAS · Корпуса подшипников · Стационарные подшипниковые узлы · Supporti ritti in due metà

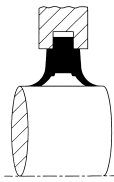

TENUTA IN POLIURETANO
"TSNG" PER SUPPORTI: SNG-SNU
"TSNG" POLYURETHAN SEAL FOR:
SNG-SNU TYPE

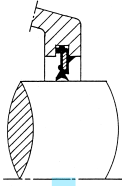

TENUTA IN GOMMA U-LOK "TSNU"
PER SUPPORTI: SNG-SNU
"TSNU" U-LOK RUBBER SEAL FOR:
SNG-SNU TYPE

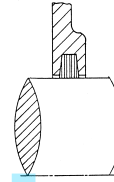

TENUTA IN FELTRO "TSNC"
PER SUPPORTI: SNG-SNU
"TSNC" FELT SEAL FOR:
SNG-SNU TYPE

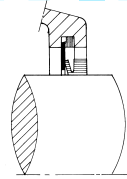

TENUTA V-RING "TSNA"
PER SUPPORTI: SNG-SNU
"TSNA" V-RING SEAL FOR:
SNG-SNU TYPE

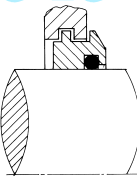

TENUTA A LABIRINTO "TSNS"
PER SUPPORTI: SNG-SNU
"TSNS" LABYRINTH SEAL FOR:
SNG-SNU TYPE

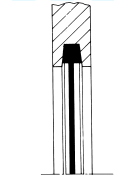

COPERCHIO DI CHIUSURA "A"
PER SUPPORTI: SNG-SNU-SN-SSN
"A" END COVER FOR:
SNG-SNU-SN-SSN-TYPE

Unità di misura (unit): mm.

Cuscinetto N. Bearing No.		Bussola (metrica)	Anello di centraggio Locating ring		Peso Weight Kg	"TSNG"	"TSNU"	"TSNC"	"TSNA"	"TSNS"	"A"	Tipo Type n.
Cuscinetto a sfere Self-alig. ball	Cuscinetto a rulli Spherical roller	Adapter sleeve	Tipo Type	Q.tà Q.ty		Tenuta in poliuretano Polyurethan seal	Tenuta in gomma U-Lok Rubber seal U-Lok	Tenuta in feltro Felt seal	Tenuta V-Ring V-Ring seal	Tenuta a labirinto Labyrinth seal	Coperchio di chiusura End cover	
1207 K	-	H 207	SR 72x8.5	2	2.2	TSNG 507	TSNU 507	TSNC 507	TSNA 507	TSNS 507	A 507-606	SNG 507-606
2207 K	22207 K	H 307	SR 72x5.5	2								
1208 K	-	H 208	SR 80x10.5	2	2.8	TSNG 508	TSNU 508	TSNC 508	TSNA 508	TSNS 508	A 508-607	SNG 508-607
2208 K	22208 K	H 308	SR 80x8	2								
1209 K	-	H 209	SR 85x5.5	2	3.0	TSNG 509	TSNU 509	TSNC 509	TSNA 509	TSNS 509	A 509	SNG 509
2209 K	22209 K	H 309	SR 85x7	1								
1210 K	-	H 210	SR 90x10.5	2	3.1	TSNG 510	TSNU 510	TSNC 510	TSNA 510	TSNS 510	A 510-608	SNG 510-608
2210 K	22210 K	H 310	SR 90x9	2								
1211 K	-	H 211	SR 100x11.5	2	4.5	TSNG 511	TSNU 511	TSNC 511	TSNA 511	TSNS 511	A 511-609	SNG 511-609
2211 K	22211 K	H 311	SR 100x9.5	2								
1212 K	-	H 212	SR 110x13	2	5.0	TSNG 512	TSNU 512	TSNC 512	TSNA 512	TSNS 512	A 512-610	SNG 512-610
2212 K	22212 K	H 312	SR 110x10	2								
1213 K	-	H 213	SR 120x14	2	6.1	TSNG 513	TSNU 513	TSNC 513	TSNA 513	TSNS 513	A 513-611	SNG 513-611
2213 K	22213 K	H 313	SR 120x10	2								
1215 K	-	H 215	SR 130x15.5	2	6.5	TSNG 515	TSNU 515	TSNC 515	TSNA 515	TSNS 515	A 515-612	SNG 515-612
2215 K	22215 K	H 315	SR 130x12.5	2								
1216 K	-	H 216	SR 140x16	2	9.0	TSNG 516	TSNU 516	TSNC 516	TSNA 516	TSNS 516	A 516-613	SNG 516-613
2216 K	22216 K	H 316	SR 140x12.5	2								
1217 K	-	H 217	SR 150x16.5	2	10.2	TSNG 517	TSNU 517	TSNC 517	TSNA 517	TSNS 517	A 517	SNG 517
2217 K	22217 K	H 317	SR 150x12.5	2								
1218 K	-	H 218	SR 160x17.5	2	12.4	TSNG 518	TSNU 518	TSNC 518	TSNA 518	TSNS 518	A 518-615	SNG 518-615
2218 K	22218 K	H 318	SR 160x12.5	2								
	23218 K	H 2318	SR 160x12.5	1								
1219 K	-	H 219	SR 170x18	2	13.5	TSNG 519	TSNU 519	TSNC 519	TSNA 519	TSNS 519	A 519-616	SNG 519-616
2219 K	22219 K	H 319	SR 170x12.5	2								
2220 K	22220 K	H 320	SR 180x12	2	17.5	TSNG 520	TSNU 520	TSNC 520	TSNA 520	TSNS 520	A 520-617	SNG 520-617
-	23220 K	H 2320	SR 180x9.7	1								
2222 K	22222 K	H 322	SR 200x13.5	2	20.5	TSNG 522	TSNU 522	TSNC 522	TSNA 522	TSNS 522	A 522-619	SNG 522-619
-	23222 K	H 2322	SR 200x10	1								
-	22224 K	H 3124	SR 215x14	2	25.5	TSNG 524	TSNU 524	TSNC 524	TSNA 524	TSNS 524	A 524-620	SNG 524-620
-	23224 K	H 2324	SR 215x10	1								
-	22226 K	H 3126	SR 230x13	2	33.0	TSNG 526	TSNU 526	TSNC 526	TSNA 526	TSNS 526	A 526	SNG 526
-	23226 K	H 2326	SR 230x10	1								
-	22228 K	H 3128	SR 250x15	2	42.0	TSNG 528	TSNU 528	TSNC 528	TSNA 528	TSNS 528	A 528	SNG 528
-	23228 K	H 2328	SR 250x10	1								
-	22230 K	H 3130	SR 270x16.5	2	53.0	TSNG 530	TSNU 530	TSNC 530	TSNA 530	TSNS 530	A 530	SNG 530
-	23230 K	H 2330	SR 270x10	1								
-	22232 K	H 3132	SR 290x17	2	55.0	TSNG 532	TSNU 532	TSNC 532	TSNA 532	TSNS 532	A 532	SNG 532
-	23232 K	H 2332	SR 290x10	1								

Plummer Blocks, 剖分式轴承座

Split Bearing Housings, Split Pillow Block Housings



SNG600 Series

For Self-Aligning Ball Bearings or Spherical Roller Bearings with Adapter Sleeves

Stehlagergehäuse · Paliers à semelle en 2 parties · Soportes de rodamientos · Soportes de Pie · Soportes Bipartidos · CHUMACERAS
CHUMACEIRAS · Корпуса подшипников · Стационарные подшипниковые узлы · Supporti ritri in due metà

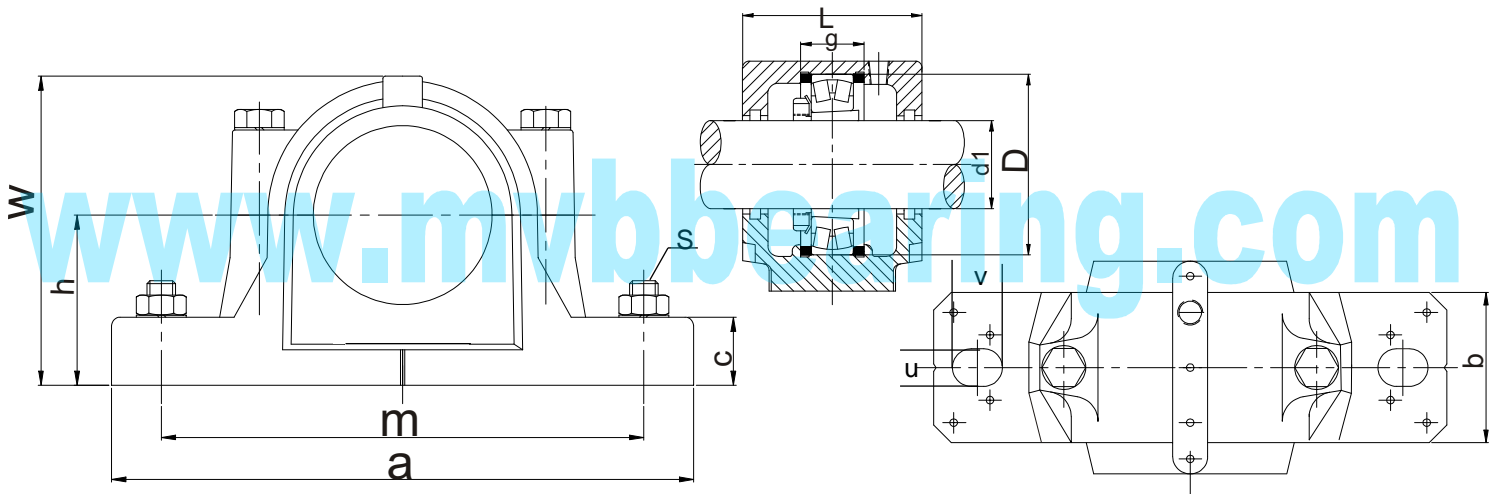

Tipo Type n.	Diam. albero Shaft DIA.		D H8	a	b	c	g H12	h jS11	L	w	m	S Bullone Bolt	U	V	d2 H12	d3 H12	f1	
	mm metric	pollici - inches																
SNG 508-607	30	1 ¹ / ₈	13 ³ / ₁₆	80	205	60	25	39	60	85	106	170	M12	15	20	51.5	59.5	5
SNG 510-608	35	1 ⁵ / ₁₆	1 ³ / ₈	90	205	60	25	41	60	90	112	170	M12	15	20	62	70.5	5
SNG 511-609	40	1 ¹ / ₂	1 ⁹ / ₁₆	100	255	70	28	44	70	95	127	210	M16	18	23	67	75.5	5
SNG 512-610	45	1 ¹¹ / ₁₆	1 ³ / ₄	110	255	70	30	48	70	105	133	210	M16	18	23	72	80.5	5
SNG 513-611	50	1 ¹⁵ / ₁₆	2	120	275	80	30	51	80	110	148	230	M16	18	24	77	85.5	5
SNG 515-612	55	2 ¹ / ₈	2 ³ / ₁₆	130	280	80	30	56	80	115	154	230	M16	18	26	87	95.5	5
SNG 516-613	60	2 ¹ / ₄	2 ⁵ / ₁₆	140	315	90	32	58	95	120	175	260	M20	22	29	92.5	101	5
SNG 518-615	65	2 ⁷ / ₁₆	2 ¹ / ₂	160	345	100	35	65	100	140	192	290	M20	22	27	102.5	111	5
SNG 519-616	70	2 ¹¹ / ₁₆	2 ³ / ₄	170	345	100	35	68	112	145	209	290	M20	22	27	131	141	6
SNG 520-617	75	2 ¹⁵ / ₁₆	3	180	380	110	40	70	112	160	215	320	M24	26	32	137.5	147.5	6
SNG 522-619	85	3 ⁵ / ₁₆	3 ³ / ₈	200	410	120	45	80	125	175	239	350	M24	26	32	147.5	157.5	6
SNG 524-620	90	3 ⁷ / ₁₆	3 ¹ / ₂	215	410	120	45	86	140	185	271	350	M24	26	32	157.5	167.5	6

Plummer Blocks,剖分式轴承座

Split Bearing Housings, Split Pillow Block Housings



SNG600 Series

For Self-Aligning Ball Bearings or Spherical Roller Bearings with Adapter Sleeves

Stehlagergehäuse · Paliers à semelle en 2 parties · Soportes de rodamientos · Soportes de Pie · Soportes Bipartidos · CHUMACERAS
CHUMACEIRAS · Корпуса подшипников · Стационарные подшипниковые узлы · Supporti ritti in due metà

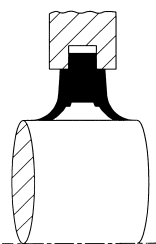

TENUTA IN POLIURETANO
"TSNG" PER SUPPORTI: SNG-SNU
"TSNG" POLYURETHAN SEAL FOR:
SNG-SNU TYPE

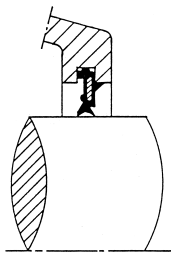

TENUTA IN GOMMA U-LOK "TSNU"
PER SUPPORTI: SNG-SNU
"TSNU" U-LOK RUBBER SEAL FOR:
SNG-SNU TYPE

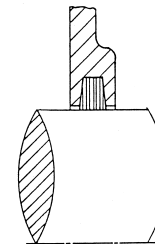

TENUTA IN FELTRO "TSNC"
PER SUPPORTI: SNG-SNU
"TSNC" FELT SEAL FOR:
SNG-SNU TYPE

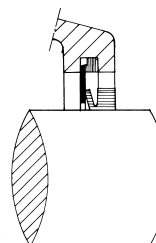

TENUTA V-RING "TSNA"
PER SUPPORTI: SNG-SNU
"TSNA" V-RING SEAL FOR:
SNG-SNU TYPE

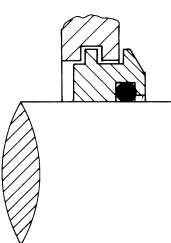

TENUTA A LABIRINTO "TSNS"
PER SUPPORTI: SNG-SNU
"TSNS" LABYRINTH SEAL FOR:
SNG-SNU TYPE

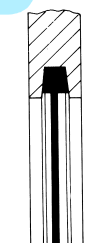

COPERCHIO DI CHIUSURA "A"
PER SUPPORTI: SNG-SNU-SN-SSN
"A" END COVER FOR:
SNG-SNU-SN-SSN-TYPE

Unità di misura (unit): mm.

Cuscinetto N. Bearing No.		Bussola (metrica) Adapter sleeve (metric)	Anello di centraggio Locating ring		Peso Weight (Kg)	"TSNG"	"TSNU"	"TSNC"	"TSNA"	"TSNS"	Coperchio di misura End cover	Tipo Type n.
Cuscinetto a sfere Self-align. ball	Cusc. orient. a rulli doppia corona di sfere Spherical roller		Tipo Type	Q.tà Q.ty		Tenuta in poliuretano Polyurethan seal	Tenuta in gomma U-Lok Rubber seal U-Lok	Tenuta in feltro Felt seal	Tenuta V-Ring V-Ring seal	Tenuta a labirinto Labyrinth seal		
1307 K	-	H 307	SR 80x9	2	2.8	TSNG 607	TSNU 607	TSNC 607	TSNA 607	TSNS 607	A 508-607	SNG 508-607
2307 K	-	H 2307	SR 80x8	1								
1308 K	21308 K	H 308	SR 90x9	2	3.1	TSNG 608	TSNU 608	TSNC 608	TSNA 608	TSNS 608	A 510-608	SNG 510-608
2308 K	22308 K	H 2308	SR 90x8	1								
1309 K	21309 K	H 309	SR 100x9.5	2	4.5	TSNG 609	TSNU 609	TSNC 609	TSNA 609	TSNS 609	A 511-609	SNG 511-609
2309 K	22309 K	H 2309	SR 100x8	1								
1310 K	21310 K	H 310	SR 110x10.5	2	5.0	TSNG 610	TSNU 610	TSNC 610	TSNA 610	TSNS 610	A 512-610	SNG 512-610
2310 K	22310 K	H 2310	SR 110x8	1								
1311 K	21311 K	H 311	SR 120x11	2	6.1	TSNG 611	TSNU 611	TSNC 611	TSNA 611	TSNS 611	A 513-611	SNG 513-611
2311 K	22311 K	H 2311	SR 120x8	1								
1312 K	21212 K	H 312	SR 130x12.5	2	6.5	TSNG 612	TSNU 612	TSNC 612	TSNA 612	TSNS 612	A 515-612	SNG 515-612
2312 K	22312 K	H 2312	SR 130x10	1								
1313 K	21213 K	H 313	SR 140x12.5	2	9.0	TSNG 613	TSNU 613	TSNC 613	TSNA 613	TSNS 613	A 516-613	SNG 516-613
2313 K	22313 K	H 2313	SR 140x10	1								
1315 K	21215 K	H 315	SR 160x14	2	12.4	TSNG 615	TSNU 615	TSNC 615	TSNA 615	TSNS 615	A 518-615	SNG 518-615
2315 K	22315 K	H 2315	SR 160x10	1								
1316 K	21316 K	H 316	SR 170x14.5	2	13.5	TSNG 616	TSNU 616	TSNC 616	TSNA 616	TSNS 616	A 519-616	SNG 519-616
2316 K	22316 K	H 2316	SR 170x10	1								
1317 K	21317 K	H 317	SR 180x14.5	2	17.5	TSNG 617	TSNU 617	TSNC 617	TSNA 617	TSNS 617	A 520-617	SNG 520-617
2317 K	22317 K	H 2317	SR 180x10	1								
1319 K	-	H 319	SR 200x17.5	2	20.5	TSNG 619	TSNU 619	TSNC 619	TSNA 619	TSNS 619	A 522-619	SNG 522-619
2319 K	22319 K	H 2319	SR 200x13	1								
-	-	-	-	-	25.5	TSNG 620	TSNU 620	TSNC 620	TSNA 620	TSNS 620	A 524-620	SNG 524-620
2320 K	22320 K	H 2320	SR 215x13	1								